

ALUCOBOND® ALUCORE® clad

2020

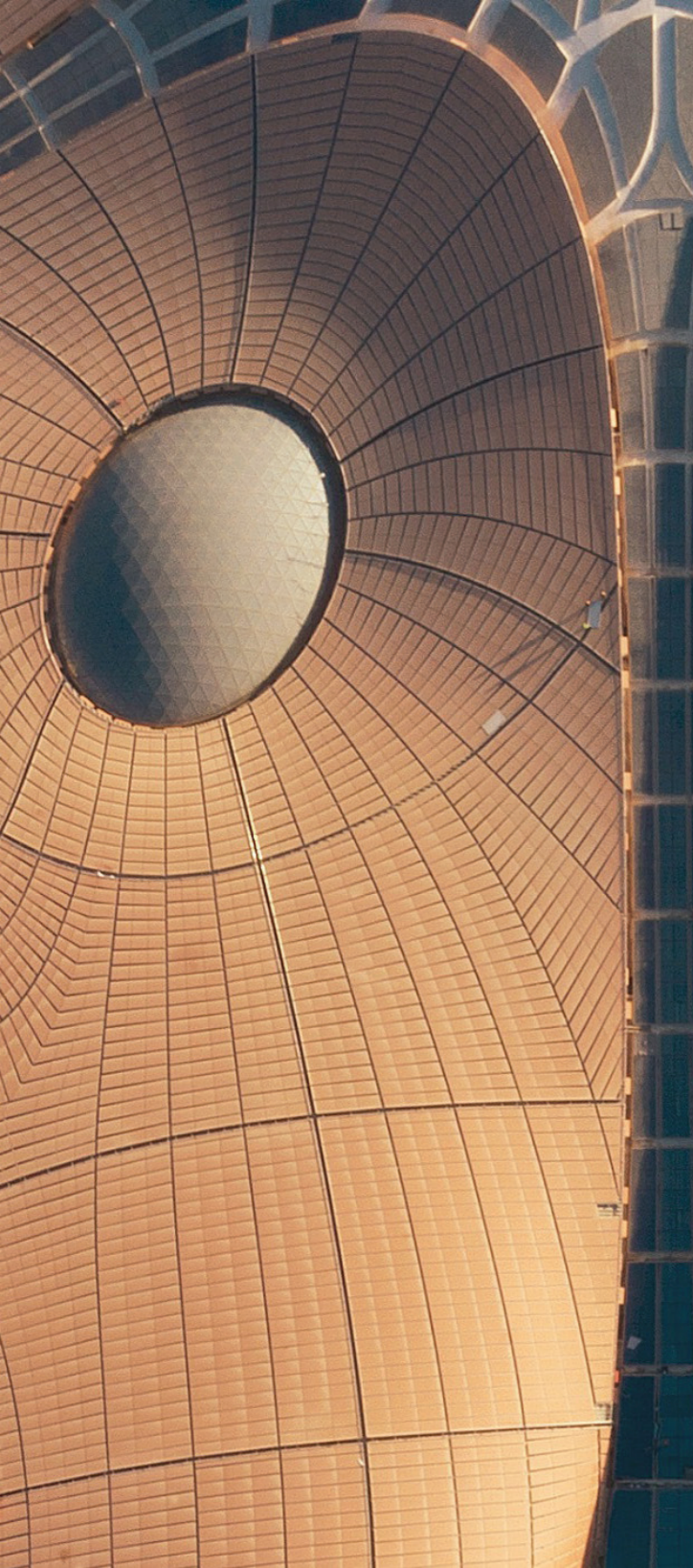

ALUCOBOND® A2 / plus / PE ALUCORE® / ALUCORE® clad

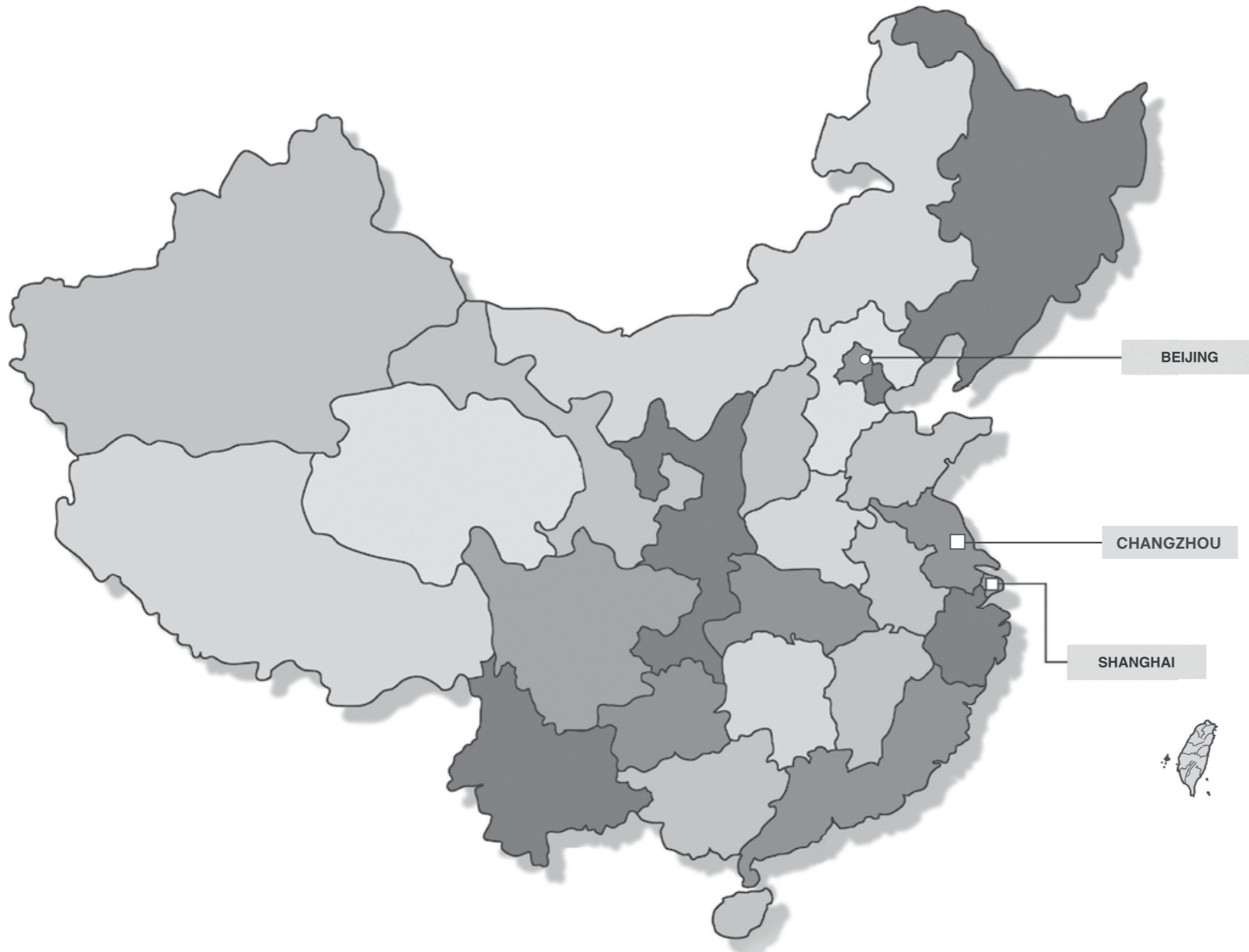

- ◆ - Alucobond Head Office
- - Alucobond Plant
- - Alucobond Sales Offices

3A COMPOSITES (CHINA) LTD.

Room 1902-1903
Feng Sheng Chuang Jian Building
Mengzi road No. 763
Huangpu Shanghai
China
Telephone: 021 5813 5353
Fax: 021 5813 5333
Email: alucobond.china@3acomposites.com
www.alucobond.com.cn

思瑞安复合材料(中国)有限公司

上海市
蒙自路763号
丰盛创建大厦
1902-1903室
电话: 021 6315 8550
传真: 021 6315 8560
电邮: alucobond.china@3acomposites.com
www.alucobond.com.cn

ALUCOBOND COMPOSITES (JIANGSU) LTD.

10 South Hehuan Road
Zhonglou, Changzhou 213023, China
Telephone: 0519 8166 5766
Fax: 0519 8166 5999

阿鲁克邦复合材料(江苏)有限公司

中国江苏常州钟楼区
合欢南路10号213023
电话: 0519 8166 5766
传真: 0519 8166 5799

SALES OFFICE IN BEIJING:

思瑞安复合材料(中国)有限公司 北京办事处
北京市朝阳区何各庄87号院
邮编: 100010
电话: 010 6552 6755
传真: 010 6552 7055

Beijing. 3A Composites (China) Ltd.

No.87 Hegezhuang Chaoyang District Beijing
100103 Beijing.
Telephone: 010 6552 6755
Fax: 010 6552 7055

For more information, please contact us.
如有需求, 敬请联络

ALUCOBOND® A2 / plus / PE

ALUCORE® / ALUCORE® clad

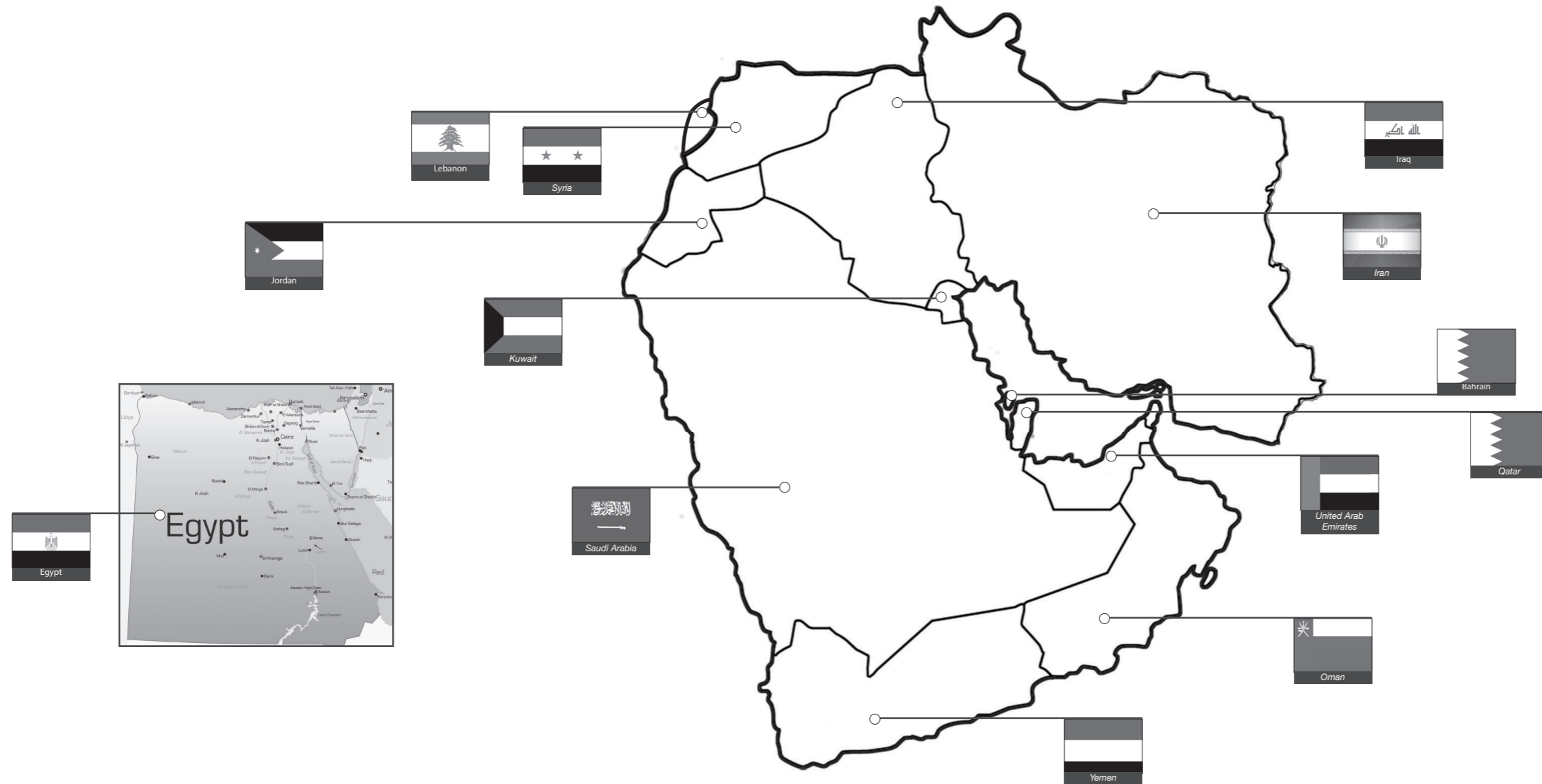

MIDDLE EAST SUPPORT CENTRE:

3A COMPOSITES MIDDLE EAST (BRANCH)
 Almas Tower, JLT
 P.O. Box: 343522
 Dubai
 United Arab Emirates
 Mobile.: +971 58 535 1721
 Email: Basel.massis@3acomposites.com
www.alucobond.com

FAR EAST SUPPORT CENTRE:

ALUCOBOND (FAR EAST) PTE LTD
 6 Shenton Way #40-05
 OUE Downtown 1
 Singapore 068809
 Tel: (65) 6303 9750
 Fax: (65) 6303 9751
 Email: sales@alucobond.com.sg
www.alucobond.com.sg

MANUFACTURER:

3A COMPOSITES GMBH
 Alusingenplatz 1
 78224 Singen/Germany
 Telephone: (49) 7731 941 2347
 Telfax: (49) 7731 941 2845
 Email: info.eu@alucobond.com
www.alucobond.com

MANUFACTURER:

3A COMPOSITES (CHINA) LTD.
 Room 1902-1903
 Feng Sheng Chuang Jian Building
 Mengzi road No. 763
 Huangpu Shanghai
 China
 Telephone: 021 5813 5353
 Fax: 021 5813 5333
 Email: alucobond.china@3acomposites.com
www.alucobond.com.cn

MANUFACTURER:

3A COMPOSITES INDIA PVT. LTD.
 Unit 852, 5th Floor, Solitaire Coperate
 Park, Andheri (East) Mumbai 400 093
 Telephone: (91) 22 4256 4500
 Fax: (91) 22 4256 4545
 Email: alucobond.india@3acomposites.com
www.alucobond.in

ALUCOBOND® PLUS



Manufacturing, Technical Service & Customer Relations

3A Composite USA
 208 W. 5th Street
 Benton, KY 42025
 800-626-3365
 270-527-4200
 270-527-1552 FAX

Davidson, NC Headquarters

3A Composite USA
 721 Jetton Street, Suite 321
 Davidson, NC 28036
 Nick Scheib
 VP of Architectural Sales
 800-626-3365
 Info.usa@3acomposites.com

ALUCOBOND® A2 / plus / PE

ALUCORE® / ALUCORE® clad

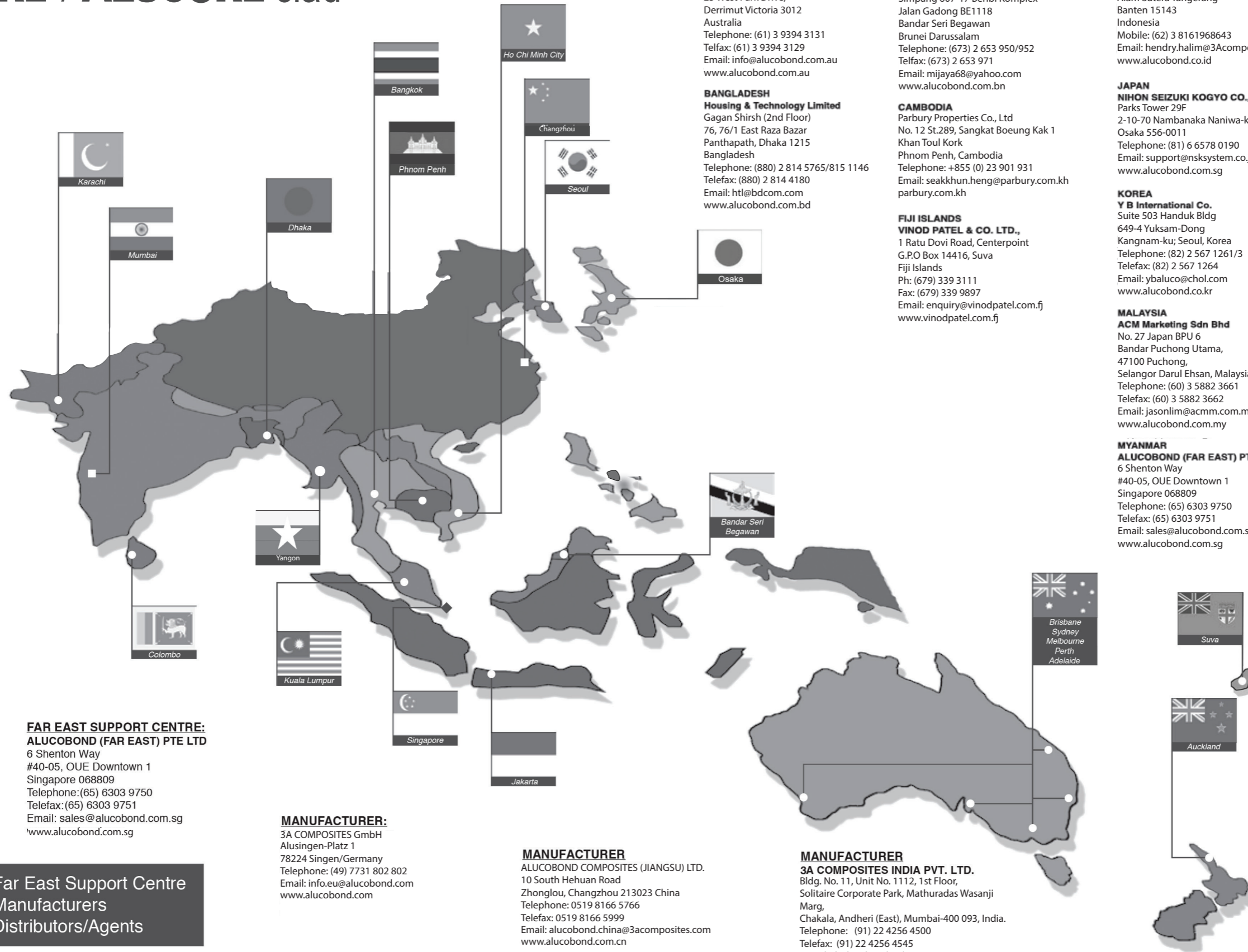

DISTRIBUTORS/AGENTS:

AUSTRALIA
Alucobond Architectural
A Division of Halifax Vogel Pty Limited
 25 West Park Drive,
 Derrimut Victoria 3012
 Australia
 Telephone: (61) 3 9394 3131
 Telfax: (61) 3 9394 3129
 Email: info@alucobond.com.au
 www.alucobond.com.au

BRUNEI
Maju Jaya Sdn Bhd
 Unit 5, Ground Floor
 Simpang 607-17 Beribi Komplex
 Jalan Gadong BE1118
 Bandar Seri Begawan
 Brunei Darussalam
 Telephone: (673) 2 653 950/952
 Telfax: (673) 2 653 971
 Email: mijaya68@yahoo.com
 www.alucobond.com.bn

INDONESIA
PT Alucobond Far East Indonesia
 Jl. Jalur Sutera Timur Kav 7A, No.6
 Alam Sutera Tangerang
 Banten 15143
 Indonesia
 Mobile: (62) 3 8161968643
 Email: hendry.halim@3Acomposites.com
 www.alucobond.co.id

NEW ZEALAND
 SPS Roofing and Building
 220 Bush Road, Rosedale
 Rosedale, Auckland 0639
 New Zealand
 Telephone: (64) 09 415 2669
 Email: info@spsbuilding.co.nz
 www.spsbuilding.co.nz

BANGLADESH
Housing & Technology Limited
 Gagan Shirsh (2nd Floor)
 76, 76/1 East Raza Bazar
 Panthapath, Dhaka 1215
 Bangladesh
 Telephone: (880) 2 814 5765/815 1146
 Telfax: (880) 2 814 4180
 Email: htl@bdcom.com
 www.alucobond.com.bd

CAMBODIA
Parbury Properties Co., Ltd
 No. 12 St.289, Sangkat Boeung Kak 1
 Khan Toul Kork
 Phnom Penh, Cambodia
 Telephone: +855 (0) 23 901 931
 Email: seakkhun.heng@parbury.com.kh
 parbury.com.kh

JAPAN
NIHON SEIZUKI KOGYO CO., LTD
 Parks Tower 29F
 2-10-70 Nambanaka Naniwa-ku
 Osaka 556-0011
 Telephone: (81) 6 6578 0190
 Email: support@nksystem.co.jp
 www.alucobond.com.sg

PAKISTAN
Pakistan Safety Glass Works Pvt Ltd
 Plot 58, Sector 28
 Korangi Industrial Area
 Karachi 75180, Pakistan
 Telephone: (92) 21 504 2275
 Telfax: (92) 21 504 2276/506 5773
 Email: info@pakistansafetyglass.com
 www.alucobond.pk

FIJI ISLANDS
VINOD PATEL & CO. LTD.,
 1 Ratu Dovi Road, Centerpoint
 G.P.O Box 14416, Suva
 Fiji Islands
 Ph: (679) 339 3111
 Fax: (679) 339 9897
 Email: enquiry@vinodpatel.com.fj
 www.vinodpatel.com.fj

KOREA
Y B International Co.
 Suite 503 Handuk Bldg
 649-4 Yuksam-Dong
 Kangnam-ku; Seoul, Korea
 Telephone: (82) 2 567 1261/3
 Telfax: (82) 2 567 1264
 Email: ybaluco@chol.com
 www.alucobond.co.kr

SINGAPORE
ALUCOBOND (FAR EAST) PTE LTD
 6 Shenton Way
 #40-05, OUE Downtown 1
 Singapore 068809
 Telephone: (65) 6303 9750
 Telfax: (65) 6303 9751
 Email: sales@alucobond.com.sg
 www.alucobond.com.sg

MALAYSIA
ACM Marketing Sdn Bhd
 No. 27 Japan BPU 6
 Bandar Puchong Utama,
 47100 Puchong,
 Selangor Darul Ehsan, Malaysia
 Telephone: (60) 3 5882 3661
 Telfax: (60) 3 5882 3662
 Email: jasonlim@acmm.com.my
 www.alucobond.com.my

SRI LANKA
JC Enterprises
 637/2 Sirimavo Bandaranayake
 Mawatha, Colombo 14
 Sri Lanka
 Telephone: (94) 11 238 5404/07
 Telfax: (94) 11 238 5403
 Email: jeykumar@sltnet.lk

MYANMAR
ALUCOBOND (FAR EAST) PTE LTD
 6 Shenton Way
 #40-05, OUE Downtown 1
 Singapore 068809
 Telephone: (65) 6303 9750
 Telfax: (65) 6303 9751
 Email: sales@alucobond.com.sg
 www.alucobond.com.sg

THAILAND
Gecons (Thailand) Co.,Ltd
 589/32-33, 8th Floor,
 Central City Tower 1
 Bangna-Trad Rd., Bangna
 Bangkok 10260
 Thailand
 Telephone: (66) 2745 7181
 Telfax: (66) 2745 7188
 Email: thanapong@geconthailand.com
 www.alucobond.co.th

FAR EAST SUPPORT CENTRE:
ALUCOBOND (FAR EAST) PTE LTD
 6 Shenton Way
 #40-05, OUE Downtown 1
 Singapore 068809
 Telephone: (65) 6303 9750
 Telfax: (65) 6303 9751
 Email: sales@alucobond.com.sg
 www.alucobond.com.sg

MANUFACTURER:
3A COMPOSITES GmbH
 Alusingen-Platz 1
 78224 Singen/Germany
 Telephone: (49) 7731 802 802
 Email: info.eu@alucobond.com
 www.alucobond.com

MANUFACTURER
ALUCOBOND COMPOSITES (JIANGSU) LTD.
 10 South Hehuan Road
 Zhonglou, Changzhou 213023 China
 Telephone: 0519 8166 5766
 Telfax: 0519 8166 5999
 Email: alucobond.china@3acomposites.com
 www.alucobond.com.cn

MANUFACTURER
3A COMPOSITES INDIA PVT. LTD.
 Bldg. No. 11, Unit No. 1112, 1st Floor,
 Solitaire Corporate Park, Mathuradas Wasanji
 Marg,
 Chakala, Andheri (East), Mumbai-400 093, India.
 Telephone: (91) 22 4256 4500
 Telfax: (91) 22 4256 4545
 E-mail Id: alucobond.india@3acomposites.com
 Website: www.alucobond.in | www.3acomposites.com

- ◆ - Alucobond Far East Support Centre
- - Alucobond Manufacturers
- - Alucobond Distributors/Agents

ALUCOBOND® A2 / plus / PE ALUCORE® / ALUCORE® clad

3A Composites India Pvt. Ltd.

Bldg. No. 11, Unit No. 1112, 1st Floor,
Solitaire Corporate Park,
Mathuradas Wasanji Marg,
Andheri (East),
Mumbai - 400 093, India.
Tel: (91) 22 4256 4500
Fax: (91) 22 4256 4545
E-mail Id: alucobond.india@3acomposites.com
Website: www.alucobond.in

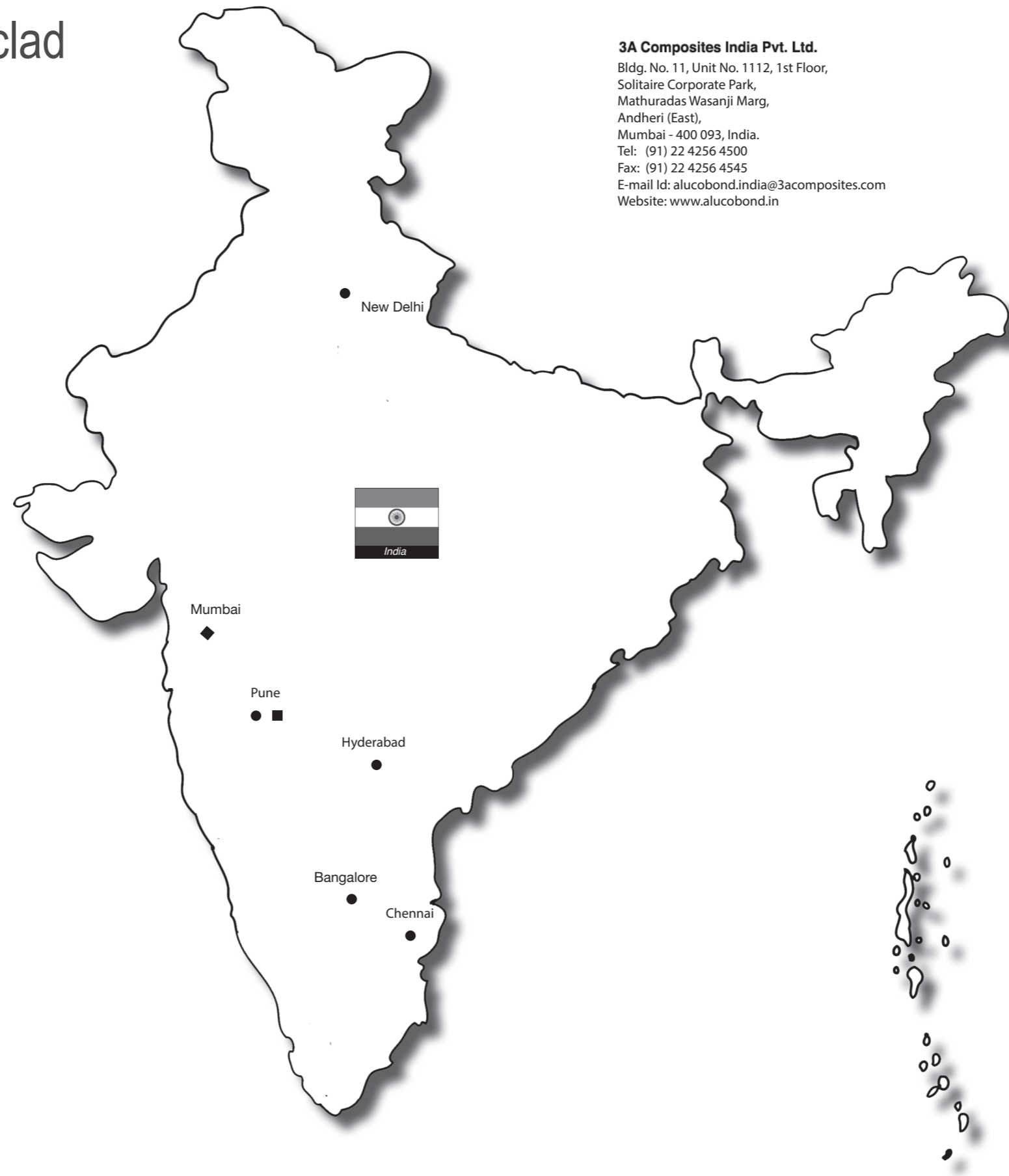

- ◆ - Alucobond Head Office
- - Alucobond Plant
- - Alucobond Sales Offices



Banyan Tree Residences Riverside | Bangkok | Thailand

January 2020

wed	thu	fri	sat	sun	mon	tue	wed	thu	fri	sat	sun	mon	tue	wed	thu	fri	sat	sun	mon	tue	wed	thu	fri							
1	2	3	4	5	6	7	8	9	10	11	12	13	14	15	16	17	18	19	20	21	22	23	24	25	26	27	28	29	30	31
wk 1				wk 2				wk 3				wk 4				wk 5														

ALUCOBOND®

Design | Construction ALUCOBOND® Ecoclad System - Riveted

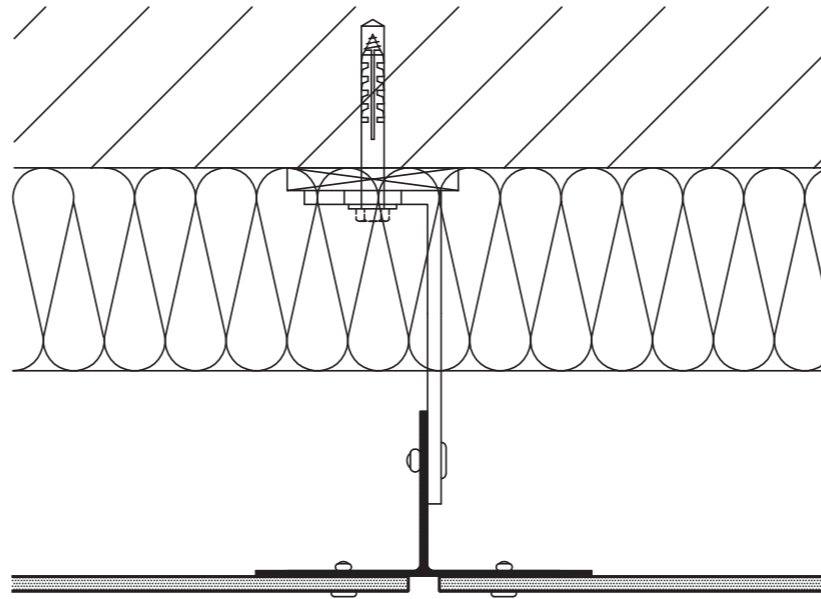

Horizontal Section

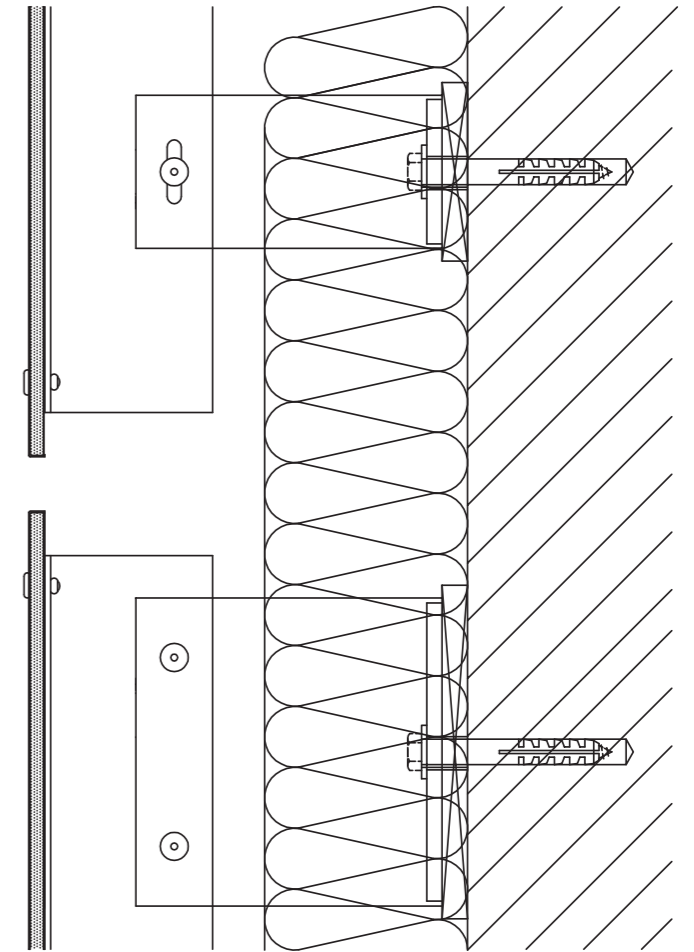

Vertical Section

All drawings are for illustration only. For design details suitable for your location contact our technical service or an ALUCOBOND® representative nearest to you.

Banyan Tree Residences Riverside
Bangkok | Thailand

Building Owner : Nirvana Daii PLC. & Nirvana River Co., Ltd.
Architect : SCDA Architects codesign with CAPA
Completed : 2018
Fabricator | Installer : Oregon Aluminium Co., Ltd.
Product : ALUCOBOND® PLUS 4mm (M2M Perforated)
Surface Finish : PVDF / FEVE coil-coated
Colour : Sunrise Silver Metallic 600, Champagne Metallic 503
Photos : Panoramic Studio



Great Northern Way Pavilion | Vancouver, BC | Canada

February 2020

sat	sun	mon	tue	wed	thu	fri	sat	sun	mon	tue	wed	thu	fri	sat	sun	mon	tue	wed	thu	fri	sat	sun	mon	tue	wed	thu	fri	sat
1	2	3	4	5	6	7	8	9	10	11	12	13	14	15	16	17	18	19	20	21	22	23	24	25	26	27	28	29
					wk 6						wk 7					wk 8								wk 9				

ALUCOBOND®

Design | Construction ALUCOBOND® Ecoclad System - Riveted

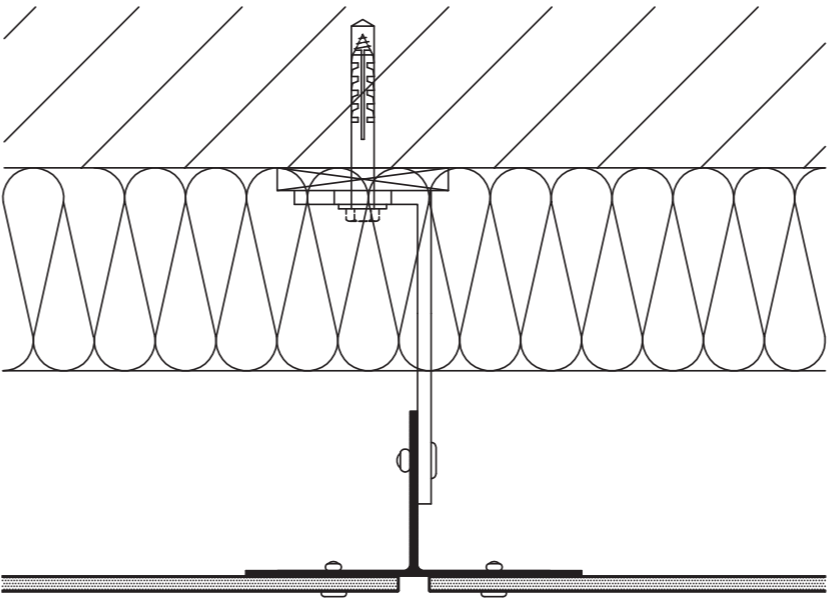

Horizontal Section

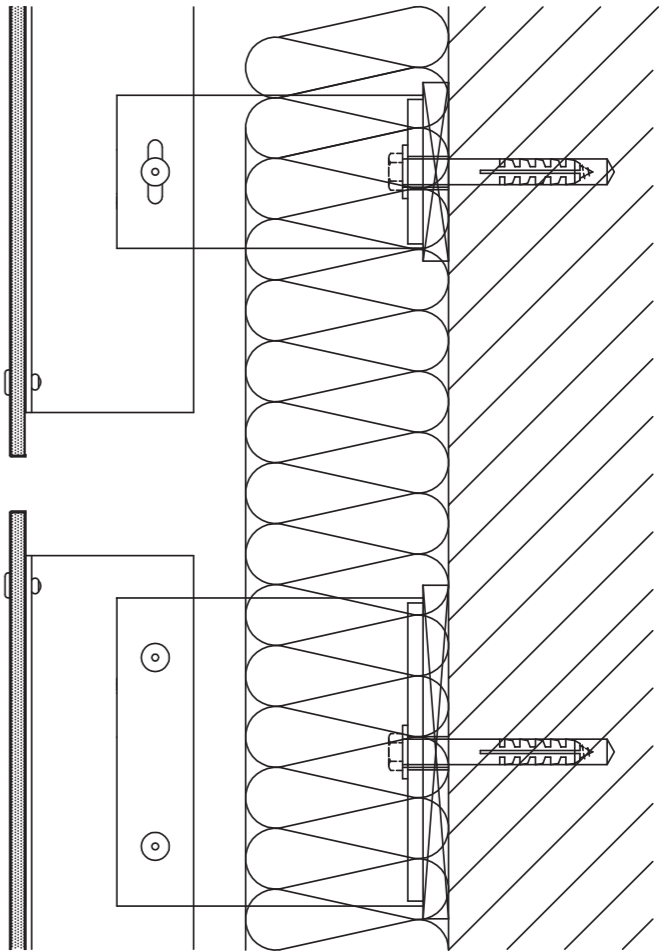

Vertical Section

All drawings are for illustration only. For design details suitable for your location contact our technical service or an ALUCOBOND® representative nearest to you.

Great Northern Way Pavilion
Vancouver, BC | Canada

Building Owner : PCI Developments
Architect : Perkins + Will
Completed : 2018
Fabricator | Installer : Keith Panel Systems
Product : ALUCOBOND® PLUS 4mm
Surface Finish : PVDF / FEVE coil-coated
Colour : Rosy Starburst (custom)
Photos : Robert Stefanowicz



ALUCOBOND®

Design | Construction ALUCOBOND® Ecoclad System - Riveted

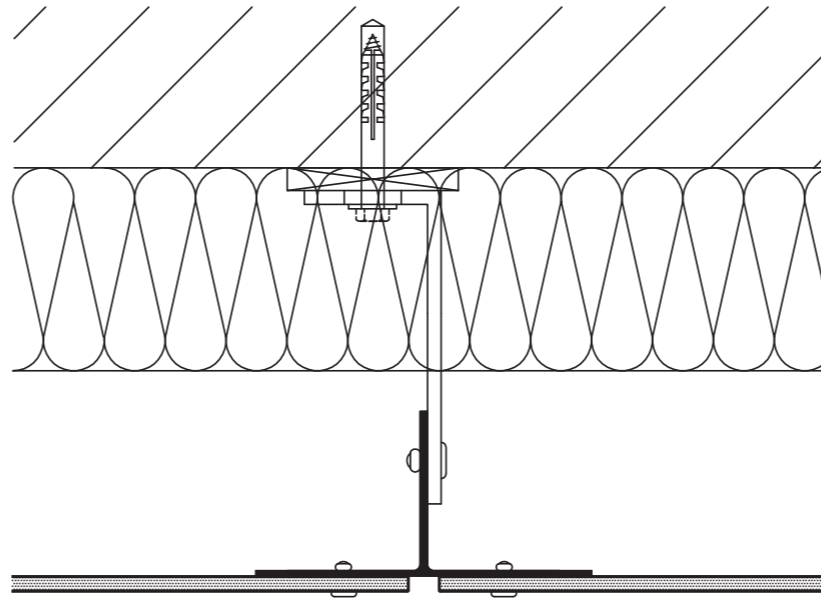

Horizontal Section

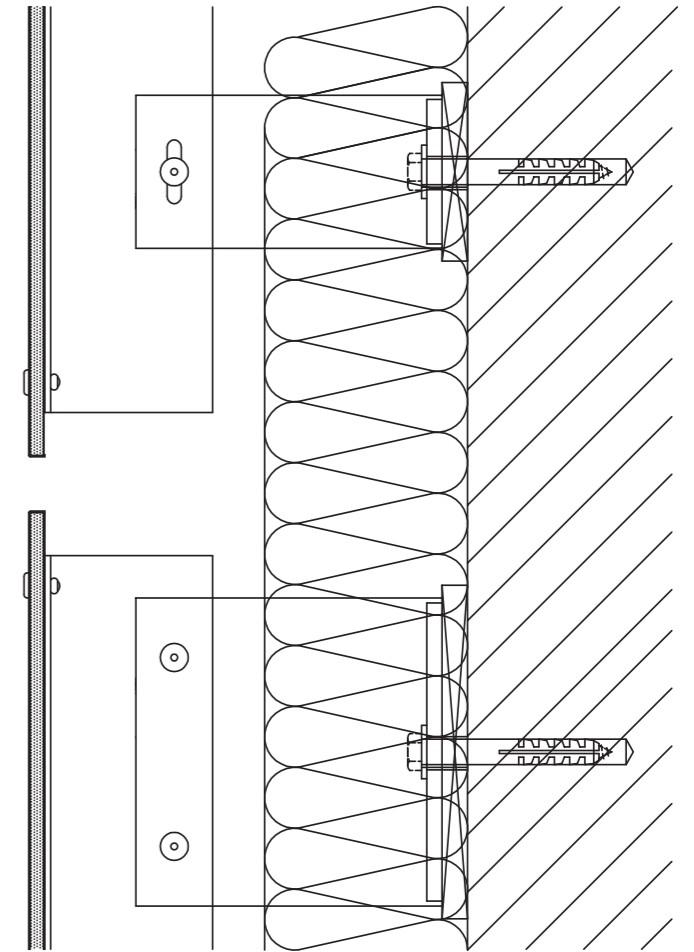

Vertical Section

All drawings are for illustration only. For design details suitable for your location contact our technical service or an ALUCOBOND® representative nearest to you.

Equinix Datacenter AM4
Amsterdam | Netherlands

Building Owner : Equinix
Architect : Benthem Crouwel Architects
Completed : 2017
Fabricator | Installer : Prince Cladding
Product : ALUCOBOND® A2 4mm
Surface Finish : PVDF / FEVE coil-coated
Colour : NaturAL PURE 402 (custom), Special Color
Photos : Jannes Linders

ALUCORE[®] clad



Beijing Daxing International Airport | Beijing | China

April 2020

wed	thu	fri	sat	sun	mon	tue	wed	thu	fri	sat	sun	mon	tue	wed	thu	fri	sat	sun	mon	tue	wed	thu							
1	2	3	4	5	6	7	8	9	10	11	12	13	14	15	16	17	18	19	20	21	22	23	24	25	26	27	28	29	30
wk 14				wk 15				wk 16				wk 17				wk 18													

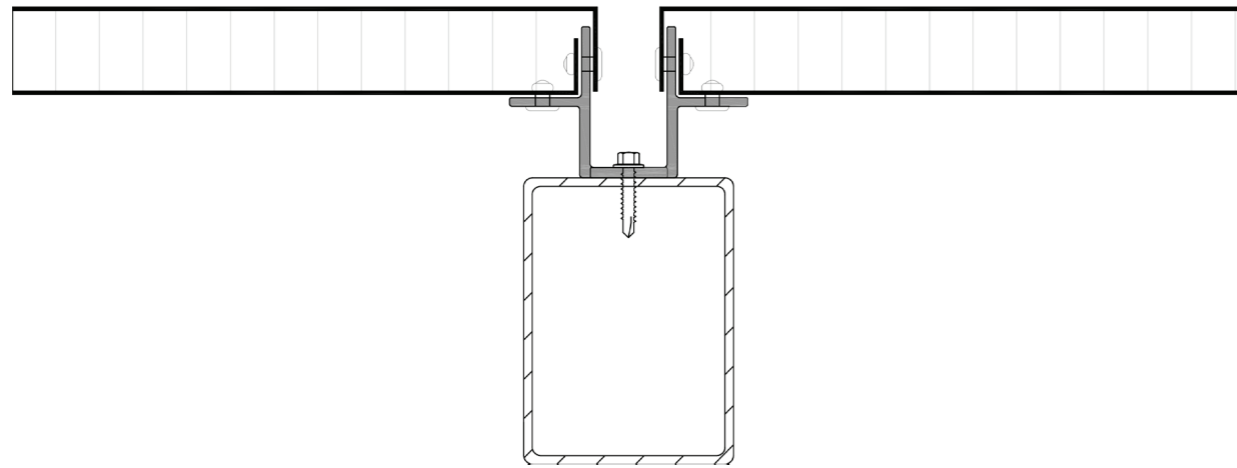

Horizontal Section

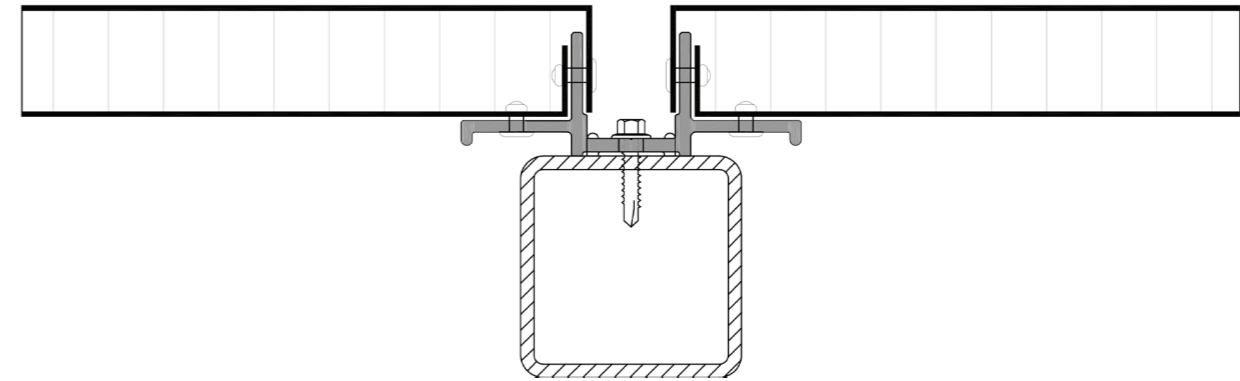

Vertical Section

All drawings are for illustration only. For design details suitable for your location contact our technical service or an ALUCOBOND[®] representative nearest to you.

Beijing Daxing International Airport
Beijing | China

Building Owner : Beijing Daxing International Airport
Architect : ADP Ingenierie
Completed : 2019
Fabricator | Installer : Beijing Construction Engineering Group
Product : ALUCORE[®] clad 25mm
Surface Finish : PVDF / FEVE coil-coated
Colour : Golden (custom), White (custom)
Photos : Zhaoqi Li



Oriental Financial Center | Beijing | China

May 2020

fri	sat	sun	mon	tue	wed	thu	fri	sat	sun	mon	tue	wed	thu	fri	sat	sun	mon	tue	wed	thu	fri	sat	sun							
1	2	3	4	5	6	7	8	9	10	11	12	13	14	15	16	17	18	19	20	21	22	23	24	25	26	27	28	29	30	31
wk 19							wk 20							wk 21							wk 22									

ALUCOBOND®

Design | Construction ALUCOBOND® Ecoclad System - Riveted

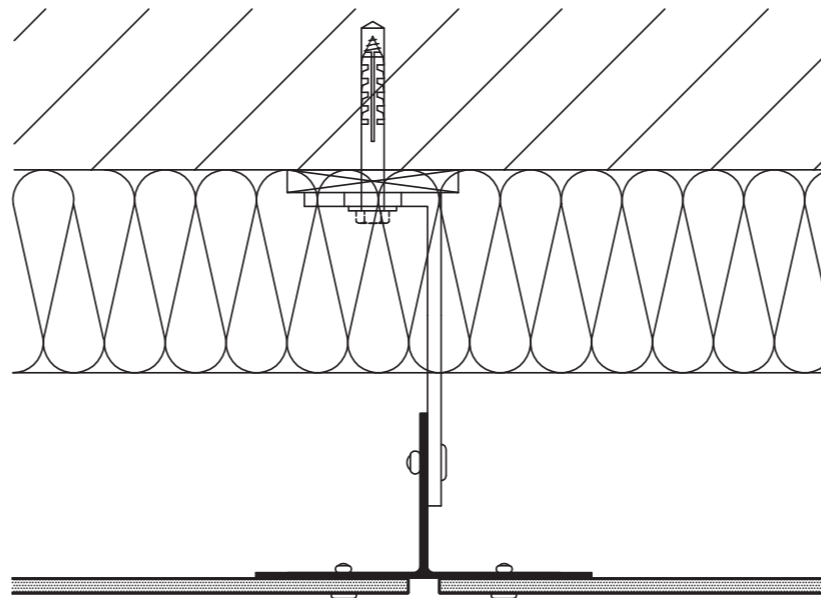

Horizontal Section

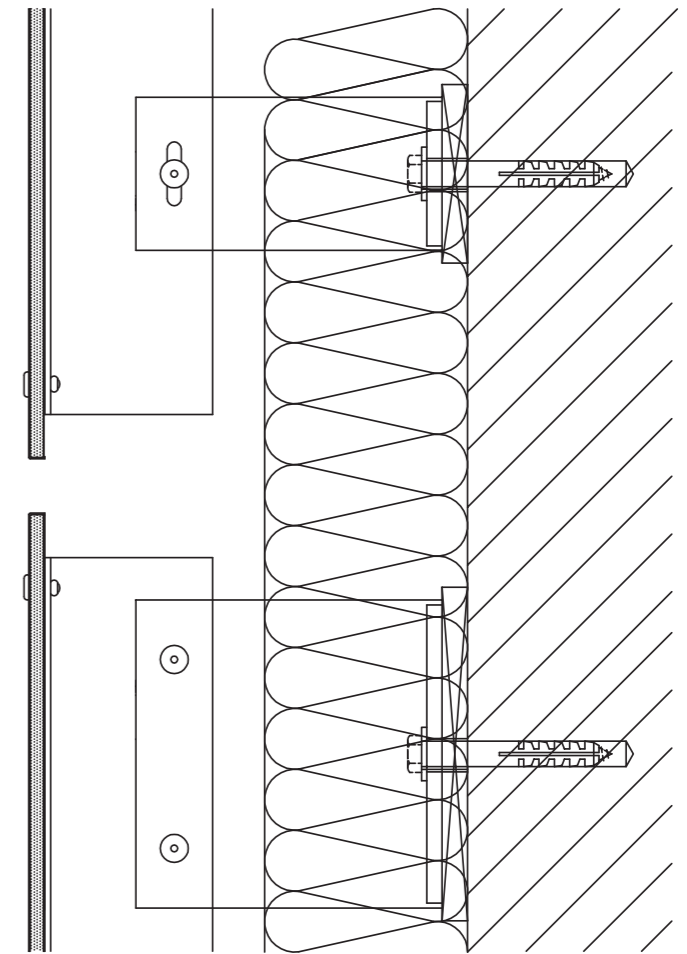

Vertical Section

All drawings are for illustration only. For design details suitable for your location contact our technical service or an ALUCOBOND® representative nearest to you.

Oriental Financial Center
Beijing | China

Building Owner : Oriental Group
Architect : ECADI
Completed : 2019
Fabricator | Installer : China Construction Eight Engineering Division Crop.Ltd
Product : ALUCOBOND® A2 4mm
Surface Finish : PVDF / FEVE coil-coated
Colour : Spectra Sakura 9917, Copper Metallic 8704
Photos : Mark Shen



Regatta Condominium | Jakarta | Indonesia

June 2020

mon	tue	wed	thu	fri	sat	sun	mon	tue	wed	thu	fri	sat	sun	mon	tue	wed	thu	fri	sat	sun	mon	tue							
1	2	3	4	5	6	7	8	9	10	11	12	13	14	15	16	17	18	19	20	21	22	23	24	25	26	27	28	29	30
wk 23							wk 24							wk 25							wk 26								

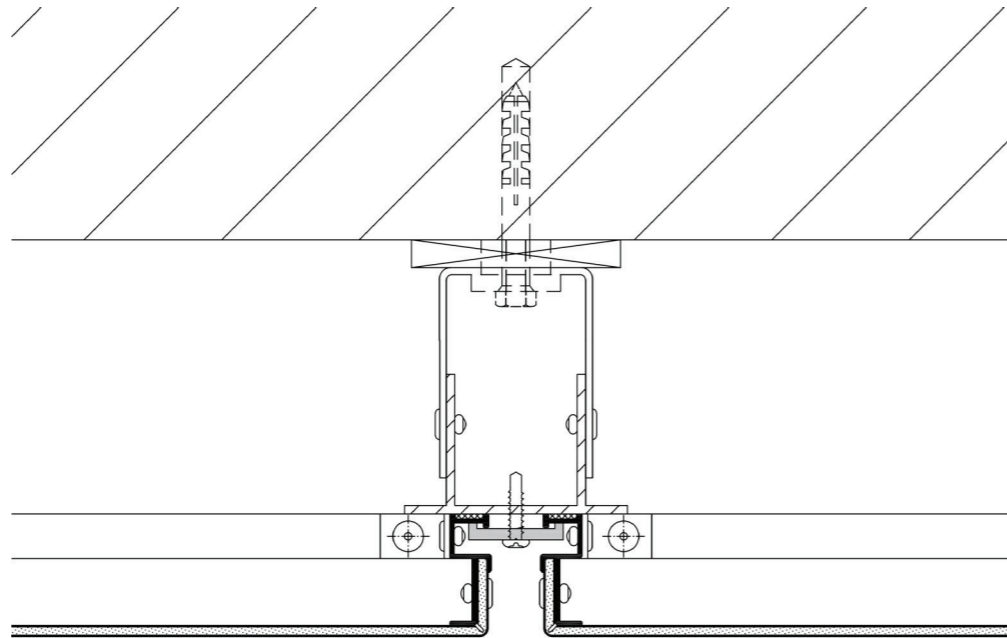

Horizontal Section

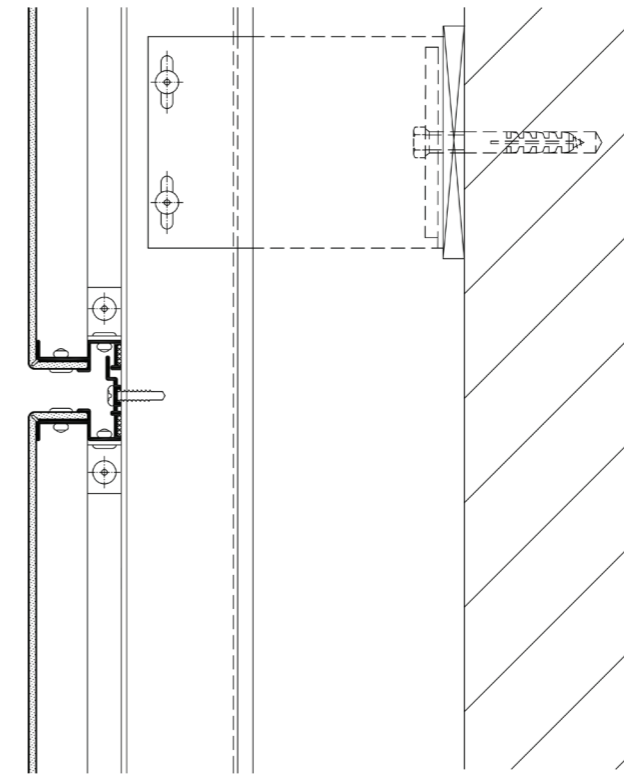

Vertical Section

All drawings are for illustration only. For design details suitable for your location contact our technical service or an ALUCOBOND® representative nearest to you.

Regatta Condominium
Jakarta | Indonesia

Building Owner : Badan Kerjasama Mutiara Buana
Architect : PT.Arteliar 6 Arsitek
Completed : 2019
Fabricator | Installer : PT.Pangkal Multikarya
Product : ALUCOBOND® PLUS 4mm
Surface Finish : PVDF / FEVE coil-coated
Colour : White 16 101
Photos : Regatta



Jewel@Changi Airport-Dome | Singapore

July 2020

wed	thu	fri	sat	sun	mon	tue	wed	thu	fri	sat	sun	mon	tue	wed	thu	fri	sat	sun	mon	tue	wed	thu	fri							
1	2	3	4	5	6	7	8	9	10	11	12	13	14	15	16	17	18	19	20	21	22	23	24	25	26	27	28	29	30	31
wk 27				wk 28				wk 29				wk 30				wk 31														

ALUCOBOND®

Design | Construction ALUCOBOND® Triangular Tray Panel System

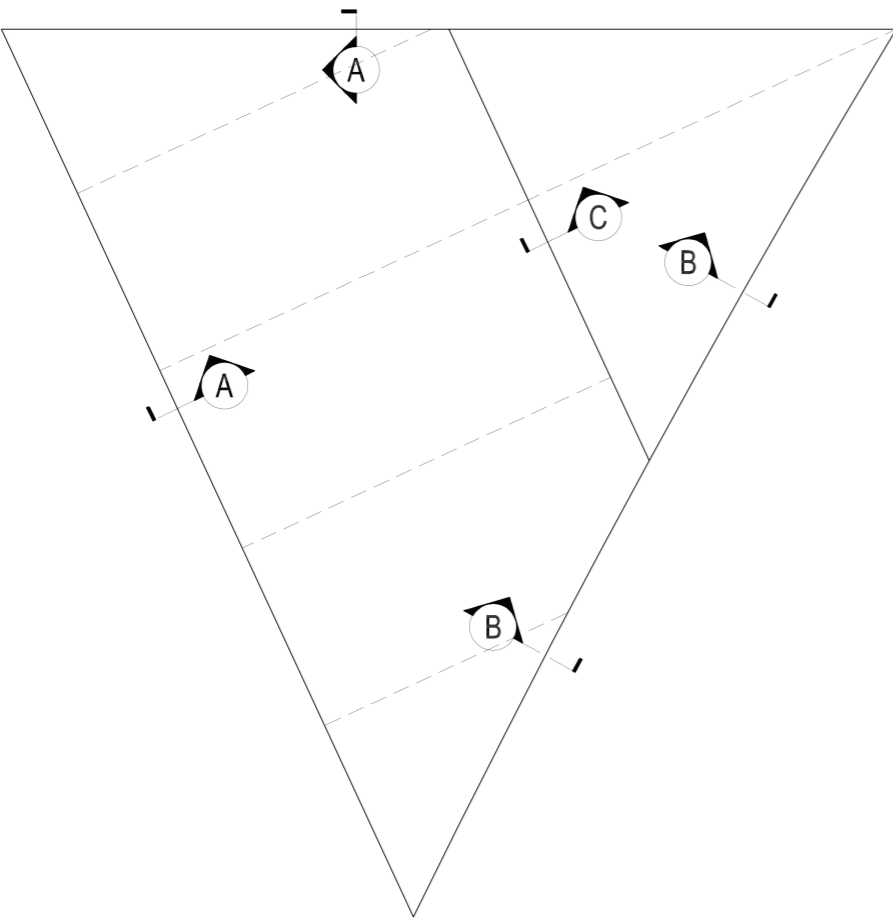

Plan View

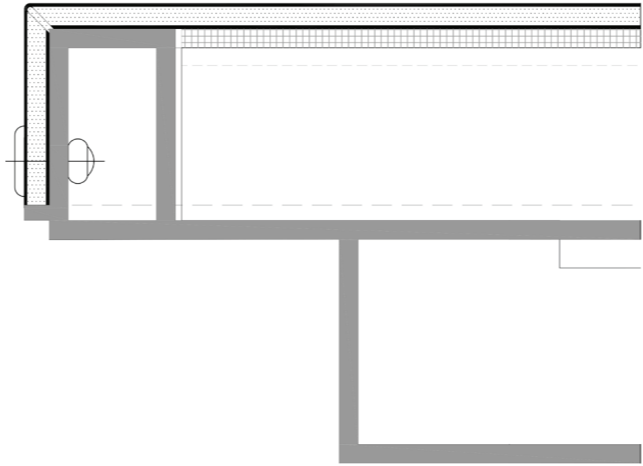

SECTION - A

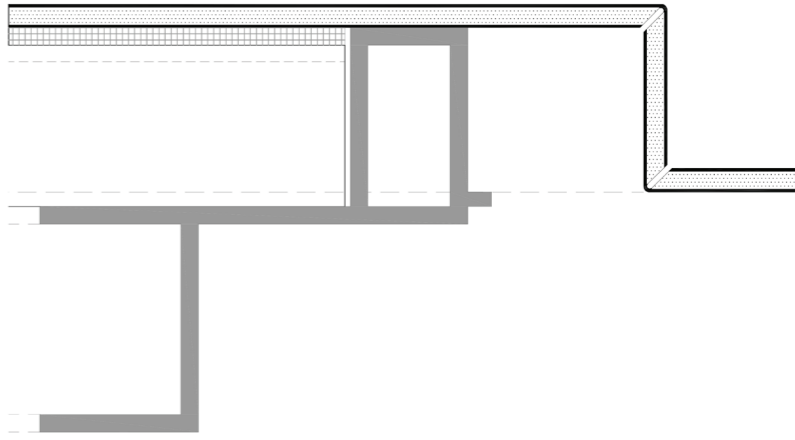

SECTION - B

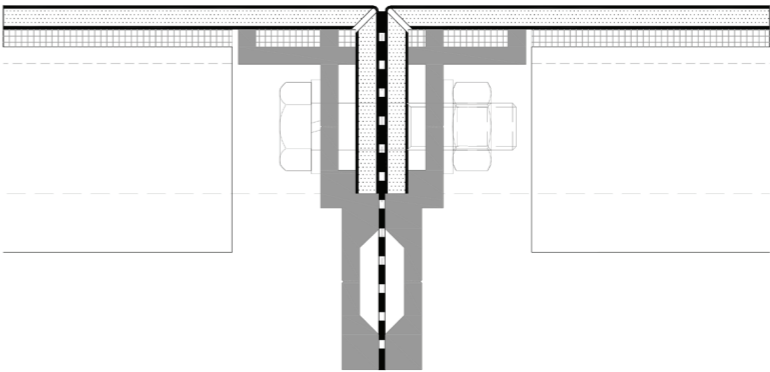

SECTION - C

All drawings are for illustration only. For design details suitable for your location contact our technical service or an ALUCOBOND® representative nearest to you.

Jewel@Changi Airport-Dome
Singapore

Building Owner : Changi Airport Group
Architect : Safdie Architect/RSP Architect
Completed : 2018
Fabricator | Installer : Mero Asia Pacific Pte Ltd
Product : ALUCOBOND® PLUS 4mm
Surface Finish : PVDF / FEVE coil-coated
Colour : Sunrise Silver Metallic 600, Jewel Silver Grey 9696 (custom)
Photos : Fotograffiti



ALUCOBOND®

Design | Construction ALUCOBOND® Ecoclad System - Riveted

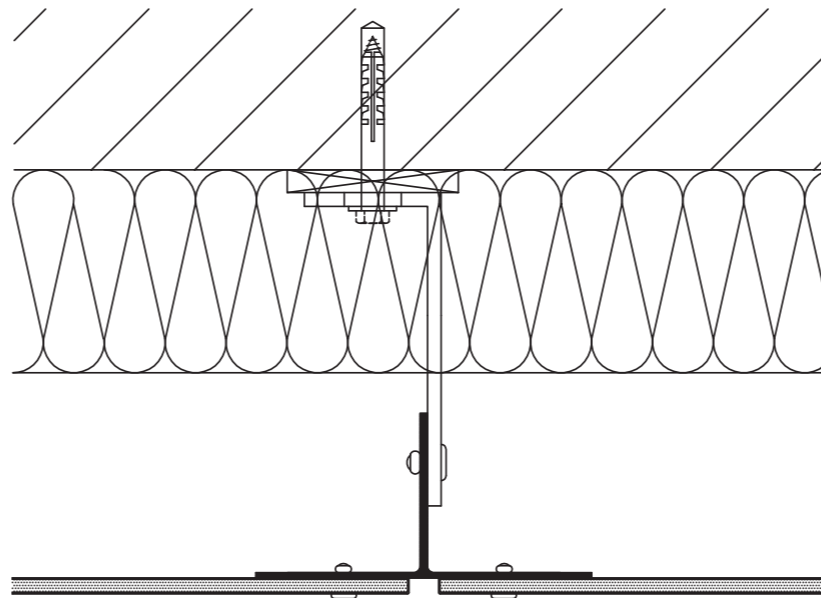

Horizontal Section

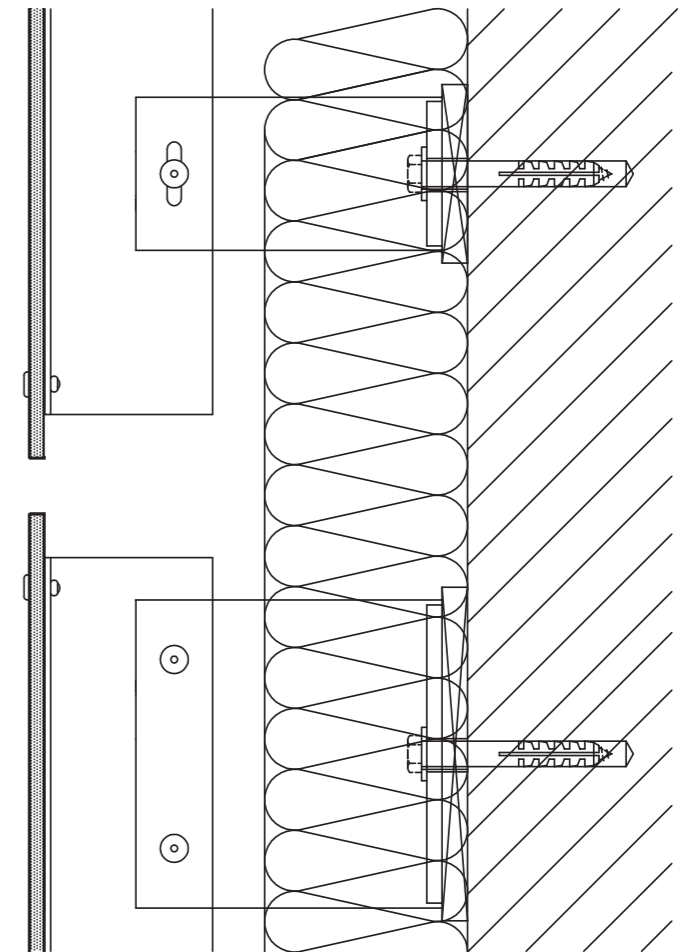

Vertical Section

All drawings are for illustration only. For design details suitable for your location contact our technical service or an ALUCOBOND® representative nearest to you.

ICONSIAM
Bangkok | Thailand

Building Owner : ICONSIAM Co., Ltd.
Architect : Urban Architects Co., Ltd.
Completed : 2018
Fabricator | Installer : SP GROUP (Sompong Panich Group) & PAC
Product : ALUCOBOND® PLUS 4mm (M2M)
Surface Finish : PVDF / FEVE coil-coated
Colour : ICONSIAM Gold 9646 (custom)
Photos : Panoramic Studio



Holcom Building | Beirut | Lebanon

September 2020

tue	wed	thu	fri	sat	sun	mon	tue	wed	thu	fri	sat	sun	mon	tue	wed	thu	fri	sat	sun	mon	tue	wed							
1	2	3	4	5	6	7	8	9	10	11	12	13	14	15	16	17	18	19	20	21	22	23	24	25	26	27	28	29	30
wk 36						wk 37						wk 38						wk 39											

ALUCOBOND®

Design | Construction ALUCOBOND® Ecoclad System - Riveted

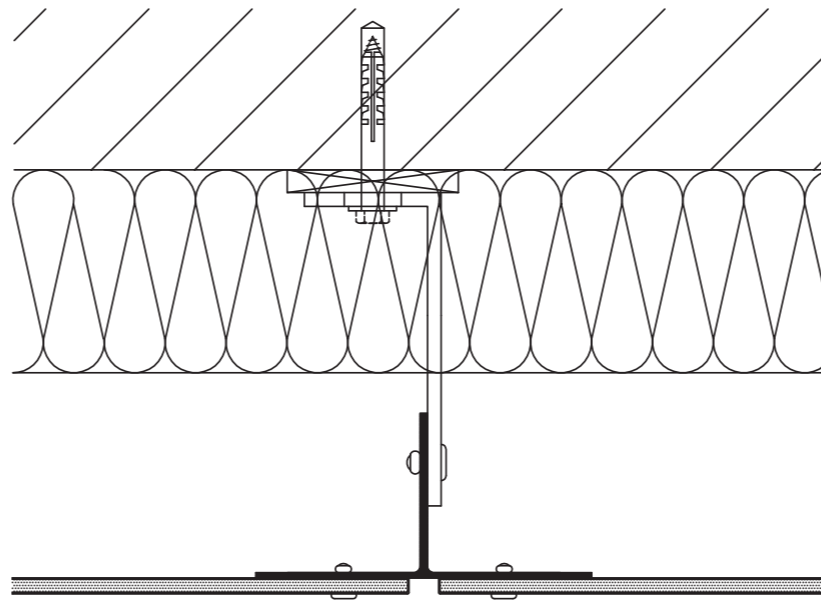

Horizontal Section

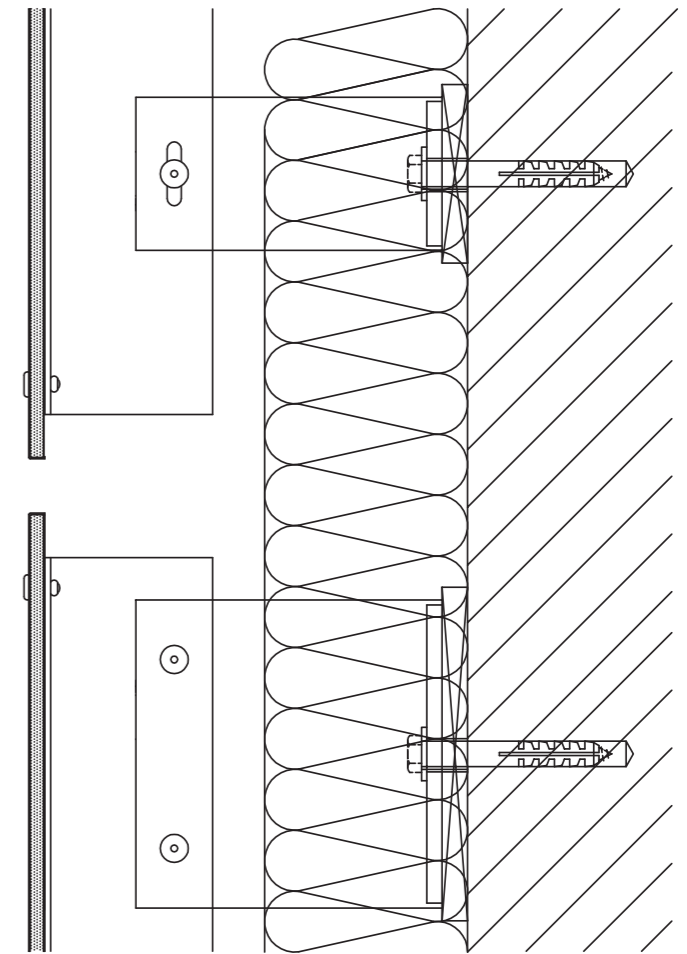

Vertical Section

All drawings are for illustration only. For design details suitable for your location contact our technical service or an ALUCOBOND® representative nearest to you.

Holcom Building
Beirut | Lebanon

Building Owner : Holcom group
Architect : Lombardini22 – Italy
Completed : 2016
Fabricator | Installer : Anid Construction
Product : ALUCOBOND® PLUS 4mm
Surface Finish : PVDF / FEVE coil-coated
Colour : NaturAL Reflect 405
Photos : Ieva Saudargaitė



Chennai Airport | Chennai | India

October 2020

thu	fri	sat	sun	mon	tue	wed	thu	fri	sat	sun	mon	tue	wed	thu	fri	sat	sun	mon	tue	wed	thu	fri	sat	sun	mon	tue	wed	thu	fri	sat
1	2	3	4	5	6	7	8	9	10	11	12	13	14	15	16	17	18	19	20	21	22	23	24	25	26	27	28	29	30	31
wk 40				wk 41				wk 42				wk 43				wk 44														

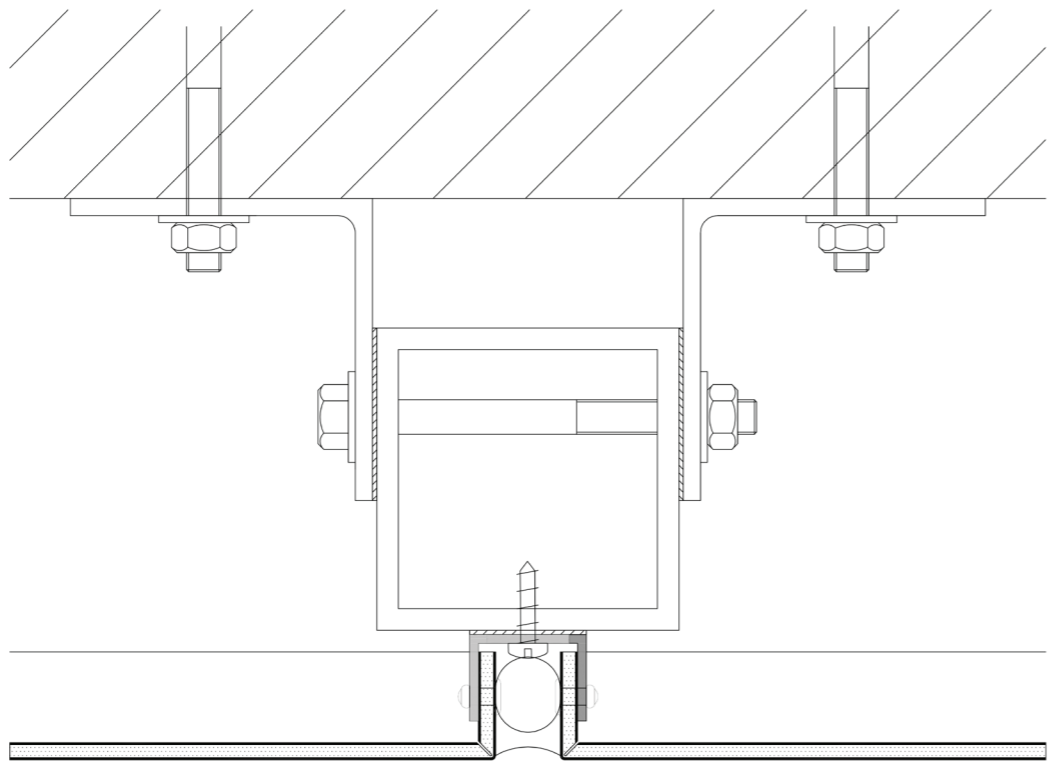

Horizontal Section

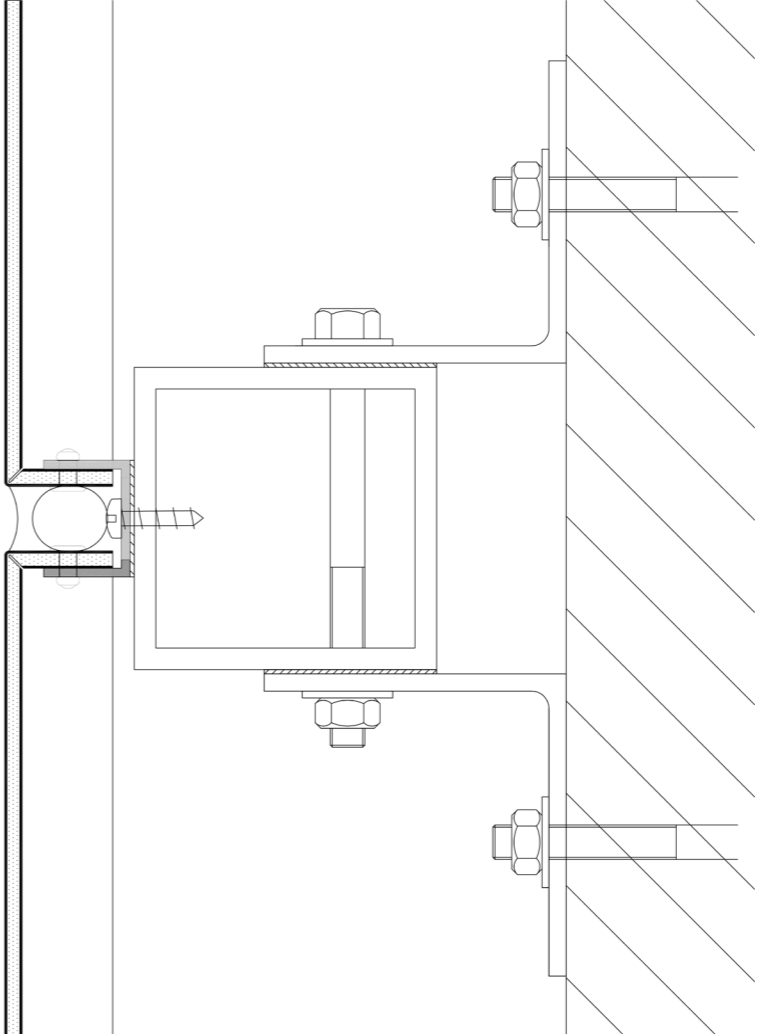

Vertical Section

All drawings are for illustration only. For design details suitable for your location contact our technical service or an ALUCOBOND® representative nearest to you.

Chennai Airport
Chennai | India

Building Owner : Airport Authorities of India
Architect : AECOM
Completed : 2018
Fabricator | Installer : RR Thulasi Builders
Product : ALUCOBOND® PE 4mm
Surface Finish : PVDF / FEVE coil-coated
Colour : Light Grey 104
Photos : Desharp studios



ALUCOBOND®

Design | Construction ALUCOBOND® Tray Panels System - Interlocking Open Joint

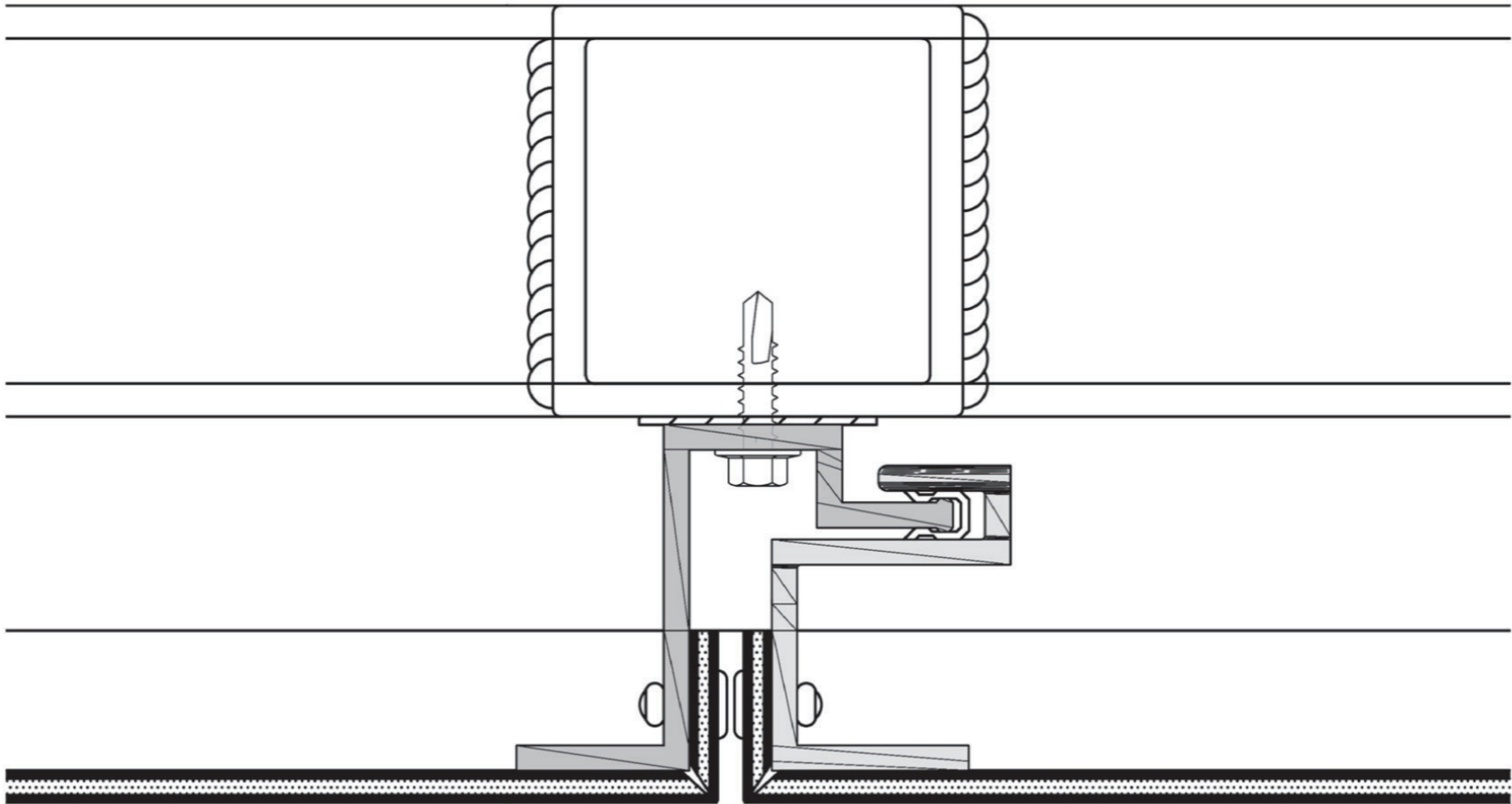

Joint Section

All drawings are for illustration only. For design details suitable for your location contact our technical service or an ALUCOBOND® representative nearest to you.

Yotel Hotel
Singapore

Building Owner : Yat Yuen Hong Company Limited
Architect : DP Architects Pte Ltd
Completed : 2017
Fabricator | Installer : Jinyue Aluminum Engineering (S) Pte Ltd
Product : ALUCOBOND® PLUS 4mm
Surface Finish : PVDF / FEVE coil-coated
Colour : NaturAL Reflect 405
Photos : Fotograffiti





C.H. Robinson Midwest Headquarters | Chicago, Illinois | USA

December 2020

tue	wed	thu	fri	sat	sun	mon	tue	wed	thu	fri	sat	sun	mon	tue	wed	thu	fri	sat	sun	mon	tue	wed	thu							
1	2	3	4	5	6	7	8	9	10	11	12	13	14	15	16	17	18	19	20	21	22	23	24	25	26	27	28	29	30	31
wk 49						wk 50						wk 51						wk 52						wk 53						

ALUCOBOND®

Design | Construction ALUCOBOND® Ecoclad System - Riveted

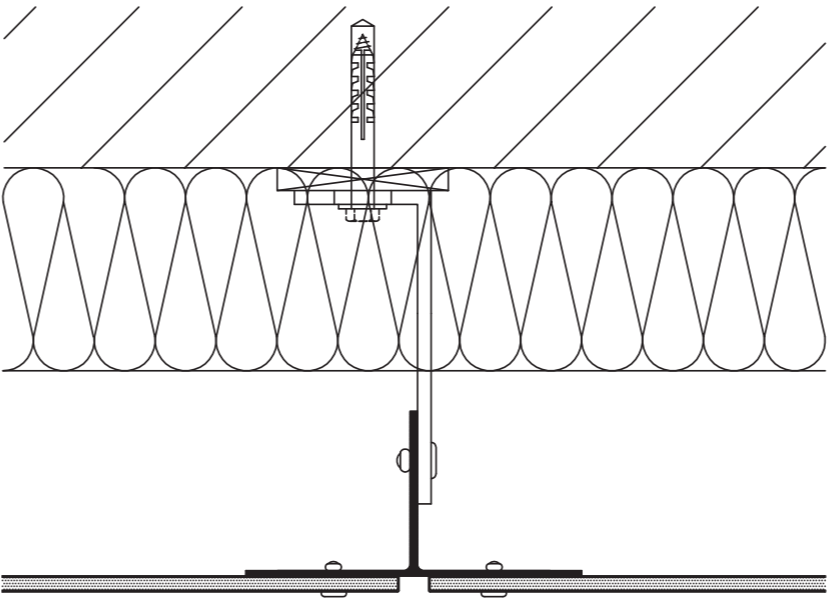

Horizontal Section

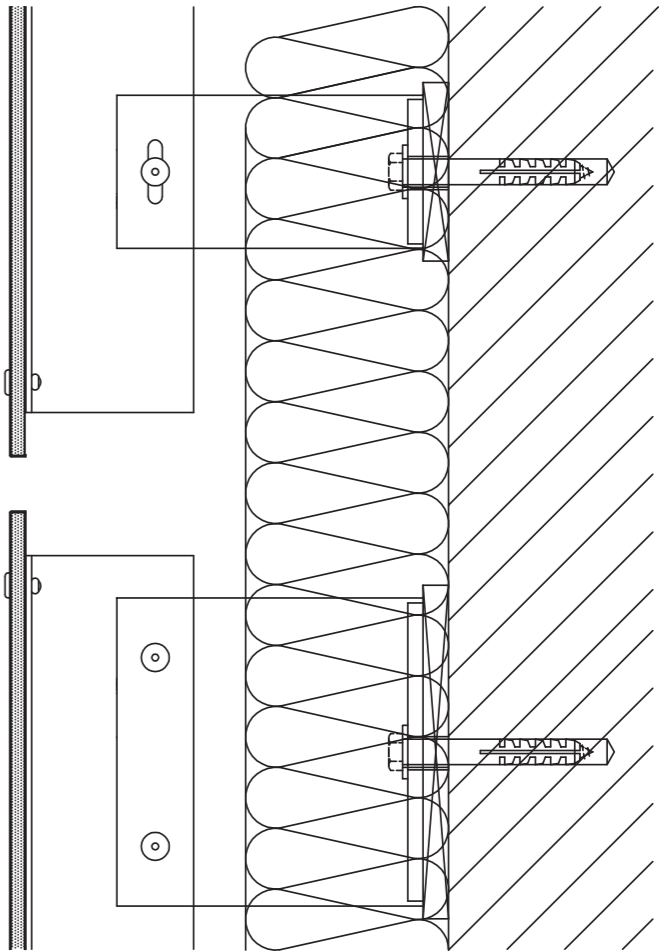

Vertical Section

All drawings are for illustration only. For design details suitable for your location contact our technical service or an ALUCOBOND® representative nearest to you.

C.H. Robinson Midwest Headquarters
Chicago, Illinois | USA

Building Owner : Sterling Bay
Architect : Skidmore, Owings & Merrill LLP (SOM)
Completed : 2018
Fabricator | Installer : Sobotec Ltd.
Product : ALUCOBOND® PLUS 4mm
Surface Finish : PVDF / FEVE coil-coated
Colour : BMB Sunlight Silver Mica (custom)
Photos : © Mark Kempf Photography

